

Brutoprijzen excl. BTW en taksen geldig tot 31/12/2023
 Prix brut hors TVA et taxes valable jusqu'au 31/12/2023

Multi-battery LED M-Series LM 30065



MULTI BATTERY
HYBRID 65W / 18V

NEW

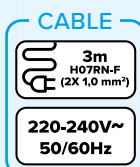

LED M-65
 COB LED TECHNOLOGY
65W/18V
 MULTI BATTERY HYBRID



DUAL SYSTEM
 BATTERY / CABLE



3 year WARRANTY ON THE LED



LM 0225E
 LM 03305
 (pag. 14)

LM 30065

+5 adapters inbegrepen
adapteurs inclus



Bosch (LM 30101) • Makita (LM 30102) • Stanley (LM 30103) •
 Metabo (LM 30104) • Milwaukee/Dewalt (LM 30105)

code	barcode	i	dimensions	quantity	weight	price
LM 30065	5420000066830	65 W	250 x 157 x 313.5 mm	4	48	139,00

Batterij niet inbegrepen / Batterie non incluse

Adapter / Adaptateur

code	barcode	quantity	price
LM 02995	5420000067295	1	4,18

Voor bevestiging op statieven LM 0225E en LM 03305 (p. 13).
 Pour montage sur trépieds LM 0225E et LM 03305 (p. 13).



voor LM 30000 en LM 30065
 pour LM 30000 et LM 30065

Multi-battery LED M-Series LM 30000



MULTI BATTERY

45W 18V

NEW



LED M-45

COB LED TECHNOLOGY

45W/18V

MULTI BATTERY

CLASS 3

4500 Lumen

3 year WARRANTY ON THE LED



LM 0225E
LM 03305
(pag. 14)

LM 30000

+5 adapters inbegrepen
adaptateurs inclus



Bosch (LM 30101) • Makita (LM 30102) • Stanley (LM 30103) •
Metabo (LM 30104) • Milwaukee/Dewalt (LM 30105)

code	Barcode	Info	Dimensions	Weight	Quantity	Price
LM 30000	5420000066823	45 W	230 x 156 x 290 mm	6	60	95,00
ADAPTER • ADAPTATEUR						
LM 02995	5420000067295	-	-	1	-	4,18

Batterij niet inbegrepen / Batterie non incluse

Multi-battery GALAXY Serie LM 30080

NEW



GALAXY MULTI BATTERY

SMD LED TECHNOLOGY

50W

2 year WARRANTY ON THE LED



5000 Lumen



5 battery pack adapters incl. : Bosch -
Makita - Stanley - Metabo - Milwaukee/Dewalt

code	Barcode	Info	Dimensions	Weight	Quantity	Price
LM 30080	5420000067578	50 W	235 x 148 x 388 mm	4	-	98,50

Batterij niet inbegrepen / Batterie non incluse

Multi-battery LED MT-100 LM 30200



NEW



LM 30200

+6 adapters inbegrepen
adaptateurs inclus



Bosch (LM 30201) • Makita (LM 30202) •
Stanley-Black & Decker (LM 30203) • Metabo (LM 30204) •
Milwaukee/Dewalt (LM 30205) • Festool (LM 30206)

LED MT-100
SMD LED TECHNOLOGY
2x50W
MULTI BATTERY

1200
Lumen

2 year
WARRANTY
ON THE LED

min. 1,30 m - max. 2,00 m



code	Barcode	Info	Dimensions	Weight	Quantity	Price
LM 30200	5420000066892	2 x 50 W	850 x 850 x 1300 mm	3	36	220,00

Batterij niet inbegrepen / Batterie non incluse

LED R-Serie



800 Lumen

LED R-10
SMD LED TECHNOLOGY
10W
RECHARGEABLE



1600 Lumen

LED R-20
SMD LED TECHNOLOGY
20W
RECHARGEABLE



MAGNETIC feet



code	barcode	i	dimensions	boxes	pieces	€
LM 32110	5420000065444	10 W	239 x 167 x 118 mm	12	288	56,30
LM 32120	5420000065451	20 W	286,5 x 221,5 x 133 mm	8	144	82,80

LED XS-Serie



NEW

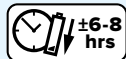

1000 Lumen

LED XS-10
COB LED TECHNOLOGY
10W
RECHARGEABLE



met karabijnhaak
avec mousqueton

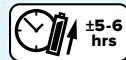

1200 Lumen

LED XS-15
COB LED TECHNOLOGY
15W
RECHARGEABLE



incl. magnetische houder
support magnétique inclus



code	barcode	i	dimensions	boxes	pieces	€	ACTIE ACTION
LM 16410	5420000066236	10 W	100 x 100 x 40 mm	36	648	36,50	29,00
LM 16515	5420000060081	15 W	171 x 124 x 43,5 mm	16	480	56,50	39,00

GALAXY RECHARGEABLE Serie

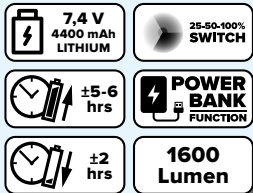

LM 0225E
LM 03305
(pag. 14)

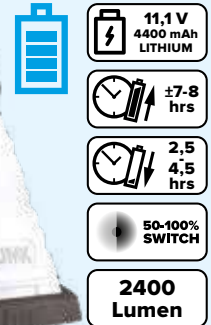

GALAXY R-COMPACT
SMD LED TECHNOLOGY
20W
RECHARGEABLE

GALAXY
SMD LED TECHNOLOGY
30W
RECHARGEABLE

code	Barcode	Info	Dimensions	Weight	Quantity	Price	ACTIE ACTION
LM 32228	5420000059313	20 W	290 x 234 x 68 mm	8	200	85,30	69,00
LM 32230	5420000049161	30 W	385 x 315 x 70 mm	5	120	118,00	105,00

DUAL LED RS-50 LM 30350

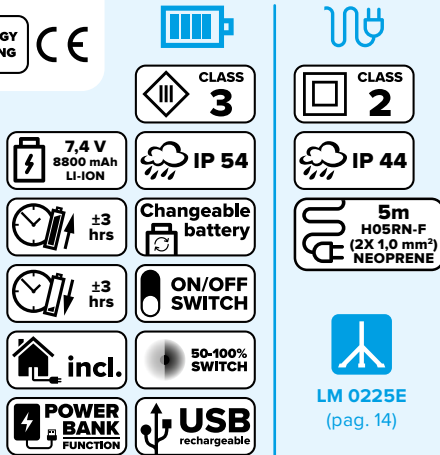

LM 0225E
(pag. 14)



LED RS-50
COB LED TECHNOLOGY
50W
RECHARGEABLE / 220V

5000 Lumen

code	Barcode	Info	Dimensions	Weight	Quantity	Price	ACTIE ACTION
LM 30350	5420000049567	50 W	300 x 265 x 130 mm	4	96	166,00	149,00

Vervangbatterij / Batterie de rechange LM 30355

code	Barcode	Info	Price
LM 30355	5420000049574	7,4 V / 8800 mAh	73,70



digitale indicator van het batterijniveau
indicateur digitale du niveau de batterie



LED F-Serie

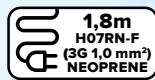

LED F-20

SMD LED TECHNOLOGY

1800 Lumen

20W

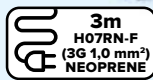

LED F-30

SMD LED TECHNOLOGY

2500 Lumen

30W

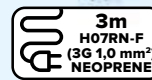

LED F-50

SMD LED TECHNOLOGY

4200 Lumen

50W

code	Barcode	Info	Dimensions	Weight	Quantity	Price
LM 36120	5420000049536	20 W	264 x 238,5 x 148,6 mm	8	160	33,20
LM 36130	5420000049543	30 W	288,6 x 288 x 168,5 mm	6	120	49,80
LM 36150	5420000049550	50 W	318,5 x 308 x 183 mm	4	96	64,20



LED FT-Serie



LED FT-50

SMD LED TECHNOLOGY

50W

4200 Lumen

LED FT-60

SMD LED TECHNOLOGY

2 x 30W

5000 Lumen

min. 0,95 m - max. 1,63 m

min. 0,92 m - max. 1,66 m

code	Barcode	Info	Dimensions	Weight	Quantity	Price
LM 36500	5420000063280	50 W	260 x 285 x 40 mm	2	18	80,10
LM 36660	5420000060135	2 x 30 W	570 x 250 x 40 mm	2	24	107,00

GALAXY-Serie



LM 0225E
LM 03305
(pag. 14)

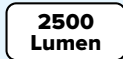

GALAXY COMPACT
SMD LED TECHNOLOGY
24W

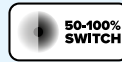
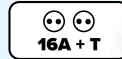

GALAXY
SMD LED TECHNOLOGY
45W



GALAXY
SMD LED TECHNOLOGY
80W



kabelprolsysteem
système d'enroulage de cable



verdraaide steun
support torsadé



code	Barcode	Power (W)	Dimensions (mm)	Weight (kg)	Quantity	Price (€)
LM 32232	5420000059320	24 W	290 x 234 x 83 mm	6	120	67,40
LM 32245	5420000046498	45 W	385 x 315 x 90 mm	4	96	90,80
LM 32300	5420000065017	80 W	464 x 365 x 84 mm	4	64	138,00

LED P+ Serie

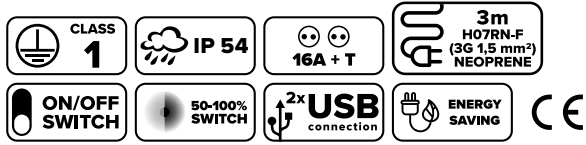

LM 0225E
(pag. 14)

LED P+100

SMD LED TECHNOLOGY

8800
Lumen

100W



WARRANTY
ON THE LED

ALL-IN-ONE

COLOR
TEMPERATURE
SELECTION

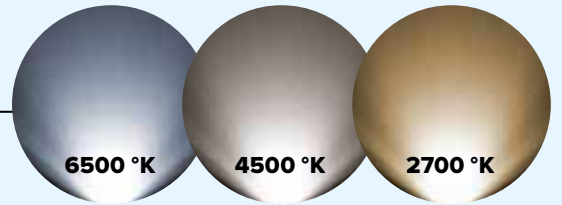

LED P+60

SMD LED TECHNOLOGY

5300
Lumen

60W



16A + T



kabelprolsysteem
système d'enroulage de cable



rubberen schokbescherming
protection antichoc en caoutchouc



code	Barcode	Power	Dimensions	Weight	Quantity	Price (€)
LM 33595	5420000065000	60 W	300 x 305.5 x 82 mm	4	96	126,00
LM 33600	5420000063273	100 W	368 x 346 x 92 mm	4	80	158,00

LED P-80 LM 33580

CLASS 1	IP 54	4000 °K	3m H07RN-F (3G 1,5 mm ²) NEOPRENE
16A + T	ON/OFF SWITCH	ENERGY SAVING	CE



LM 0225E
(pag. 14)

7200
Lumen

LED P-80
SMD LED TECHNOLOGY
80W

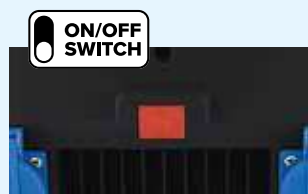

code						€
LM 33580	5420000042483	80 W	342 x 295 x 112 mm	4	48	129,00

LED LB-50 LM 37500

CLASS 1	IP 54	6000 °K	5m H07RN-F (3G 1,5 mm ²) NEOPRENE
16A + T	ON/OFF SWITCH	ENERGY SAVING	CE



LM 0225E
(pag. 14)

5500
Lumen

LED LB-50
SMD LED TECHNOLOGY
50W



code						€
LM 37500	5420000062153	50 W	280 x 286 x 280 mm	4	40	105,00

LED N-Serie



3m
H07RN-F
(3G 1,5 mm²)
NEOPRENE

LED N-50

SMD LED TECHNOLOGY

4580
Lumen

50W



5m
H07RN-F
(3G 1,5 mm²)
NEOPRENE

LED N-80

SMD LED TECHNOLOGY

7200
Lumen

80W



5m
H07RN-F
(3G 1,5 mm²)
NEOPRENE

LED N-120

SMD LED TECHNOLOGY

10800
Lumen

120W



KABELPROLSYSTEEM - SYSTÈME D'ENROULAGE DE CÂBLE

code	Barcode	i	Dimensions	Weight	Quantity	€	ACTIE ACTION
LM 34750	5420000060050	50 W	330 x 315 x 220 mm	4	32	105,00	95,00
LM 34780	5420000060067	80 W	400 x 354 x 258 mm	3	36	158,00	139,00
LM 34812	5420000060074	120 W	500 x 440 x 295 mm	2	12	290,00	275,00

LED B-180 LM 35180

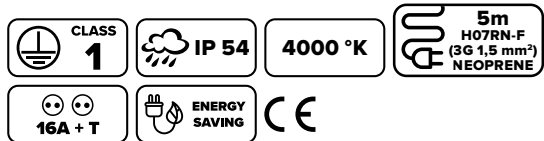

5m
H07RN-F
(3G 1,5 mm²)
NEOPRENE



16000
Lumen

LED B-180

SMD LED TECHNOLOGY

180W

KABELPROLSYSTEEM - SYSTÈME D'ENROULAGE DE CÂBLE

code	Barcode	i	Dimensions	Weight	Quantity	€
LM 35180	5420000060128	180 W	530 x 400 x 360 mm	2	16	319,00

LL-24 LM 36724

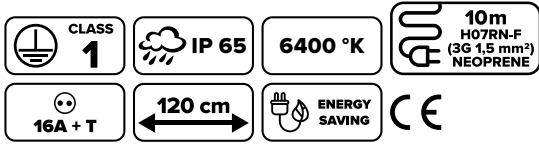

LED Doorlusverlichting
Éclairage en boucle LED

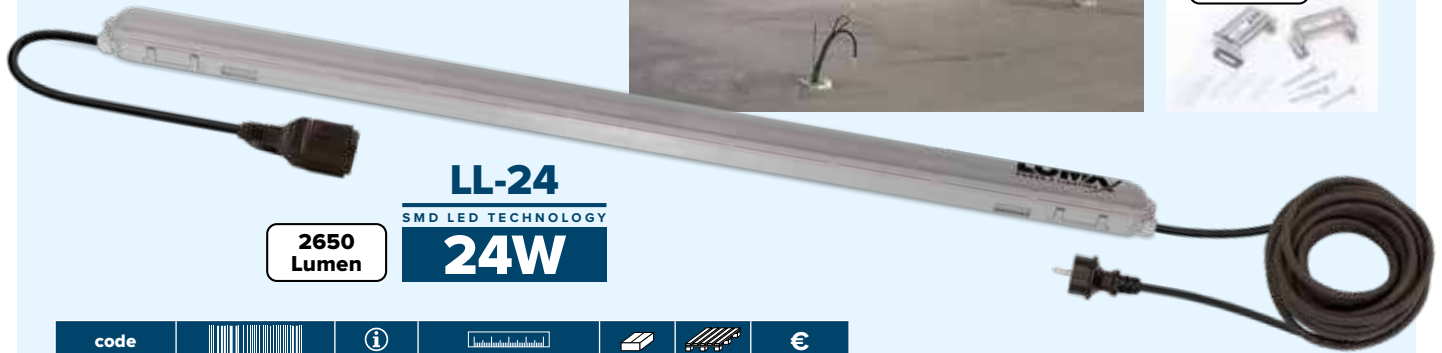

LL-24
SMD LED TECHNOLOGY
24W
2650 Lumen

code	Barcode	Info	Dimensions	Weight	Quantity	Price
LM 36724	5420000062177	24 W	1200 x 72 x 58 mm	6	90	77,58

LS-45 LM 23046



LED lichtslang - 45 m
Bande LED - 45 m

LS-45
SMD LED TECHNOLOGY
128W
200 Lumen/m



45+5m GRATIS GRATIS

code	Barcode	Dimensions	Weight	Quantity	Price
LM 23046	5420000065383	264 x 251 x 128 mm	1	96	160,00

inclusief stekker
prise inclus

Toebehoren / Accessoires LM 23050

voor LED lichtslang LM 23046
pour bande LED LM 23046

code	Barcode	Quantity	Price
LM 23050	5420000062405	1	16,83



INHOUD - CONTENU :

- 1x T-connector
- 3x Pin-connector
- 3x Eindstuk/embout
- 1x PVC lijm/colle
- 1x EU stekker/fiche + kabel/câble 1,5m HO5RN-F 2X 1,0 mm²

WS-Serie LED Wandstraler • Projecteur murale LED

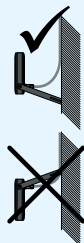

WS-20

SMD LED TECHNOLOGY

1800 Lumen

20W



WS-30

SMD LED TECHNOLOGY

2500 Lumen

30W



WS-50

SMD LED TECHNOLOGY

4200 Lumen

50W

code	Barcode	Info	Dimensions	Box	LEDs	€
LM 31320	5420000063785	20 W	174 x 130 x 76 mm	10	350	22,40
LM 31330	5420000063792	30 W	224 x 168 x 80 mm	8	288	33,80
LM 31350	5420000063808	50 W	258 x 192 x 83,5 mm	6	180	46,50

WSS-Serie LED Wandstraler • Projecteur murale LED

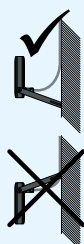

WSS-20

SMD LED TECHNOLOGY

1800 Lumen

20W



WSS-30

SMD LED TECHNOLOGY

2500 Lumen

30W



WSS-50

SMD LED TECHNOLOGY

4200 Lumen

50W

code	Barcode	Info	Dimensions	Box	LEDs	€
LM 31720S	5420000063815	20 W	174 x 195 x 76 mm	10	300	29,20
LM 31730S	5420000063822	30 W	224 x 250 x 80 mm	8	144	45,10
LM 31750S	5420000063839	50 W	258 x 276 x 83,5 mm	6	108	58,50

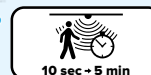

LED HP-Serie



LM 0225E
LM 03305
(pag. 14)

GENERATION

LIGHTER • BRIGHTER • ECONOMICAL



LED HP-150
SMD LED TECHNOLOGY

13400 Lumen

150W



LED HP-200
SMD LED TECHNOLOGY

18250 Lumen

200W



LED HP-400
SMD LED TECHNOLOGY

37600 Lumen

400W

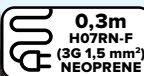

60000 Lumen

LED HP-600
COB LED TECHNOLOGY

600W
HIGH LUMEN



HIGH POWER LEDS

statief niet inbegrepen
trépied non inclus

code		i				€
LM 61015	5420000060098	150 W	345 x 280 x 68 mm	2	48	236,00
LM 61020	5420000060104	200 W	425 x 325 x 77 mm	2	32	297,00
LM 61040	5420000060111	400 W	595 x 475 x 95 mm	1	18	550,00
LM 61260	5420000064836	600 W	560 x 470 x 110 mm	1	12	590,00

STATIEVEN • TRÉPIEDS

LM 0225E

Min: 1,09 m
Max: 2,75 m

max
30 kg

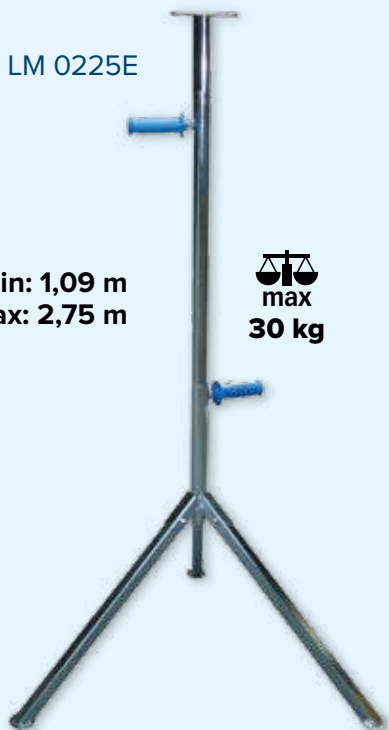

Heavy Duty

LM 03305

Min: 1,40 m
Max: 3,00 m

max
60 kg

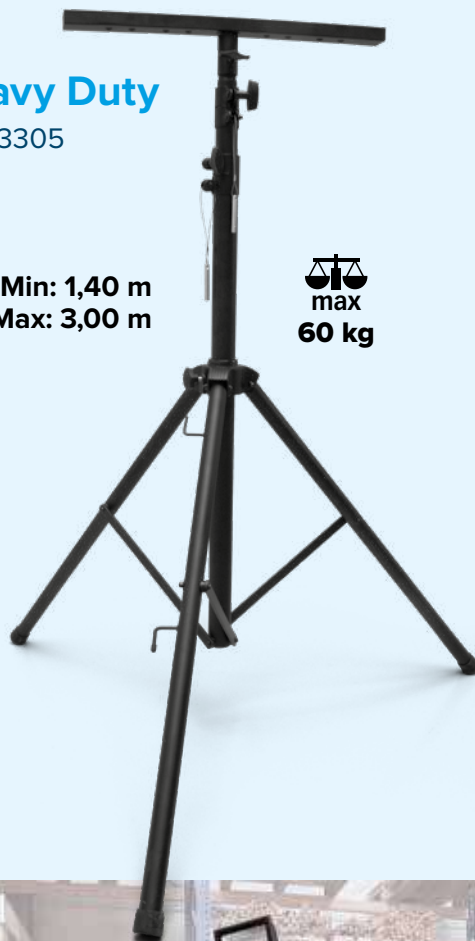



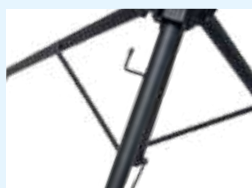

extra beveiliging
broche anti-chute



kabelprolsysteem
système d'enroulage de câble



werflamp niet inbegrepen
lampe de chantier non inclus

code					€
LM 0225E	5420000018938	109-275 cm	3	36	56,70
LM 03305	5420000062412	140-300 cm	2	36	129,90

	LM 30000 LM 30065 LED M-Series	LM 33595 LM 33600 LED P+ Serie	LM 33580 LED P-80	LM 37500 LED LB-50	LM 32300 LM 32245 LM 32232 GALAXY-Serie	LM 61015 LM 61020 LM 61040 LM 61260 LED HP-Serie	LM 32230 LM 32228 GALAXY Rechargeable	LM 30350 LED RS-50	LM 25108 PL-108
LM 0225E	✓	✓	✓	✓	✓	✓	✓	✓	✓
LM 03305	-	-	-	-	✓	✓	✓	-	✓

HL-180 LM 12180

LIGHT BY **CREE** LEDs
 IP X4
 5200 °K
 7200 °K
 SHOCK RESISTANT 1m
 3 x AAA DURACELL (incl.)
 CE



6 modes 180 Lumen

code	barcode	i	box	€	ACTIE ACTION
LM 12180	5420000061743	HL-180	6	31,10	26,00

HL-250 LM 12325

LIGHT BY **CREE** LEDs
 IP 64
 6100 °K
 7100 °K
 SHOCK RESISTANT 2m
 USB rechargeable
 Changeable battery
 Incl. 3,7 V 800 mAh LI-POLYMER
 of ou 3 x AAA (not incl.)
 ±2,5 hrs
 CE



5 modes 250 Lumen

code	barcode	i	box	€
LM 12325	5420000061750	HL-250	6	50,20

HL-350 LM 12005

LIGHT BY **CREE** LEDs
 IP X4
 6500 °K
 SHOCK RESISTANT 2m
 incl. 3,7 V 1200 mAh LITHIUM
 ±2,5 hrs
 USB rechargeable
 CE



Flexible rubber band

((SENSOR))
 5 modes 350 Lumen
 230°

code	barcode	i	box	€
LM 12005	5420000065666	HL-350	12	18,90

TCT-250S LM 12440

LUMILEDS
 The Brighter Choice
 IP X4
 6500 °K
 SHOCK RESISTANT 2m
 3 x AAA DURACELL (incl.)
 CE



((SENSOR))
 8 modes 250 Lumen

code	barcode	i	box	€	ACTIE ACTION
LM 12440	5420000061767	TCT-250S	6	46,60	38,00

TCT-300 LM 12590

LIGHT BY **CREE** LEDs
 IP 64
 7100 °K
 8300 °K
 SHOCK RESISTANT 2m
 Incl. 3,7 V 2600 mAh Li-ion
 ±4 hrs
 USB rechargeable
 Changeable battery
 CE



6 modes 300 Lumen

code	barcode	i	box	€
LM 12590	5420000061774	TCT-300	6	64,60

TCT-640 LM 12600

IP 66
 6500 °K
 7100 °K
 SHOCK RESISTANT 2m
 USB rechargeable
 Changeable battery
 CE
 Incl. 3,8 V 1900 mAh Li-Ion
 of ou 3 x AA (not incl.)
 ±2,5-3 hrs



6 modes 640 Lumen

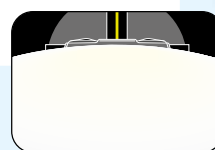

Ultrabrede verlichting
 Éclairage ultra-large

code	barcode	i	box	€	ACTIE ACTION
LM 12600	5420000063068	TCT-640	6	74,50	69,00

PEN LIGHT - display 16 st/pcs LM 51955



**STRONG
ALU BODY**

**200
Lumen**

PEN LIGHT
SMD LED TECHNOLOGY
BATTERY



180°
draibare magnetische clip
clip magnétique rotatif

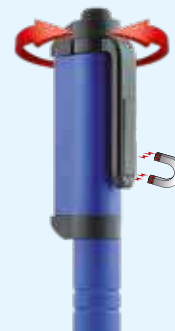

code	Barcode	Info	Dimensions	Pieces	€
LM 51955	5420000042445	6 LED	158 x 30 x 16 mm	64	13,17

Zolang de voorraad strekt / Jusqu'à épuisement du stock

DUO LED - display 12 st/pcs LM 52000



**80
Lumen**

DUO LED
BULB & SMD LED TECHNOLOGY
BATTERY



**MAGNETIC
foot**



code	Barcode	Info	Dimensions	Pieces	€
LM 52000	5420000039285	20 + 3 LED	100 x 70 x 30 mm	48	8,73

INSPEC DUO LED GRIP - display 9 st/pcs LM 52070



**MAGNETIC
back**

**MAGNETIC
foot**



led bulb
led à diode



ophangbaar
mise en suspension



**INSPEC
DUO LED GRIP**
COB LED TECHNOLOGY
BATTERY

**280
Lumen**

code	Barcode	Dimensions	Pieces	€
LM 52070	5420000065758	215 x 53 x 45 mm	36	11,97

Zolang de voorraad strekt / Jusqu'à épuisement du stock



INSPEC DUO GRIP LM 52111



code	Barcode	Power	Dimensions	Quantity	Price
LM 52111	5420000062382	3 W	245 x 58,5 x 45,8 mm	24	27,87

INSPEC PRO LM 52125

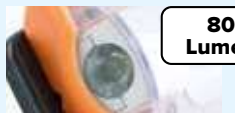

code	Barcode	Power	Dimensions	Quantity	Price
LM 52125	5420000042490	5 W	211 x 56 x 38 mm	20	46,30

INSPEC UV LM 51005

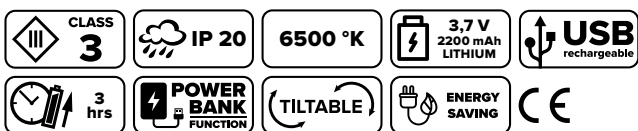

500 Lumens

4 MODES
100% - 50% - Top - UV



Battery indicator



MAGNETIC foot

40 Lumens

code	Barcode	Dimensions	Quantity	Price
LM 51005	5420000063976	298 x 49 x 35 mm	24	35,10

Zolang de voorraad strekt / Jusqu'à épuisement du stock

LED T-1000 - display 6 st/pcs LM 15095

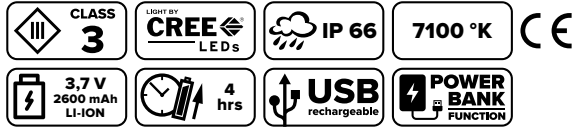

LED T-1000

CREE LED TECHNOLOGY

1000
Lumen

10W

RECHARGEABLE



code	barcode	info	dimensions	quantity	price	action
LM 15095	5420000063983	10 W	Ø 29 x 150 mm	24	€ 83,20	ACTIE ACTION 69,90

1 Micro USB-poort (opladen), 1 USB-poort (Power Bank-functie)
1 port micro USB (charge), 1 port USB (fonction Power Bank)

LED zaklamp waterproof Torche LED étanche LM 16330



330
Lumen



kantelbaar
inclinable



geleverd met draaglint
livré avec bandoulière

code	barcode	dimensions	quantity	price
LM 16330	5420000046696	188 x 148 x 128 mm	12	€ 42,00

LED T-GUN 950 spot light LM 18625



950
Lumen

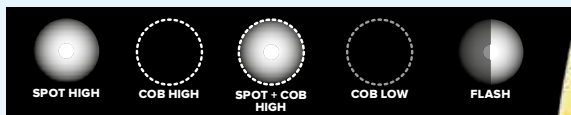

geleverd met draaglint
livré avec bandoulière



code	barcode	dimensions	quantity	price
LM 18625	5420000064003	148 x 165 x 76 mm	3	€ 95,90

handenvrij
mains libres

Verlengkabels • Rallonges

code					€	ACTIE ACTION
VINYL - H05VV-F						
LM 40515	5420000039681	15 m	8	200	28,65	
LM 40526	5420000034945	25 m	4	144	46,20	
NEOPREEN • NEOPRÈNE - H07RN-F / PLASTIC CAP						
LM 40745	5420000041554	5 m	10	180	20,40	
LM 40750	5420000019607	10 m	4	144	37,50	33,75
LM 40755	5420000041561	15 m	5	90	54,90	
LM 40765	5420000019614	25 m	2	104	82,30	76,00
LM 40770	5420000047488	40 m	2	60	148,00	
NEOPREEN • NEOPRÈNE - H07RN-F / RUBBER CAP						
● LM 40605	5420000067776	5 m	50	100	36,95	
● LM 40625	5420000066731	25 m	-	35	132,00	

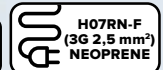
LM 40515
LM 40526LM 40605
LM 40625 **NEW**2P+A
2P+T
250V - 16ALM 40745
LM 40750
LM 40755
LM 40765
LM 40770

Machine-aansluitkabel • Câble de raccordement

230V - 16A



code				€
H07RN-F 3G1,5				
LM 40435	5420000041509	5 m	20	14,02
H05RN-F 2X1,0				
LM 40425	5420000047334	5 m	20	7,18
H07RN-F 2X1,0				
LM 40453	5420000041530	3 m	30	5,94
LM 40455	5420000041547	5 m	20	8,60
H07RN-F 2X1,5				
LM 40443	5420000041516	3 m	30	6,64
LM 40445	5420000041523	5 m	20	10,99

LM 40435

3 geleiders
3 conducteurs2 geleiders
2 conducteurs

LM 40453

LM 40425

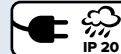
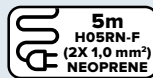

LM 40455

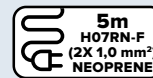
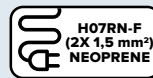
LM 40443
LM 40445

Driewegskoppelstekker • Fiche femelle triple

LM 48310
LM 48325

16A 250V~

Max. 3680W



code				€
LM 48310	5420000046955	10 m	1	82,30
LM 48325	5420000046962	25 m	1	127,00
NI 243300	5420000039612	block	50	10,60
NI 243303	5420000039629	0,3 m	30	15,04
NI 243305	5420000039636	5 m	20	28,02
NI 243310	5420000039643	10 m	8	43,30
NI 243325	5420000039650	25 m	4	88,60

Neopreen verlengkabels • Allonges néoprène



EN 60309

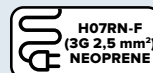

2P+A
2P+T
250V - 16A



code		i		€
LM 44102	5420000043015	2 m	25	15,46
LM 44105	5420000066656	5 m	10	24,77



3P+N+A
3P+N+T
400V - 32A

code		i		€
LM 44345	5420000043046	25 m	1	252,00



3P+N+A
3P+N+T
400V - 16A

code		i		€
LM 44110	5420000043022	10 m	4	74,10
LM 44125	5420000043039	25 m	2	138,00



3P+N+A
3P+N+T
400V - 32A

code		i		€
LM 44566	5420000043053	25 m	1	337,00



3P+N+A
3P+N+T
400V - 64A

code		i		€
LM 44580	5420000044326	25 m	1	688,00

Verdeelblok - 4 stopcontacten • Bloc multiprises - 4 prises



250V - 16A



EN 60309



code		i		€
LM 41200	5420000046542	block	10	25,36
LM 41203	5420000046559	3 m	10	41,75
LM 41210	5420000046566	10 m	4	57,90

Stekkerdozen met schakelaar • Prises avec interrupteur



code		i		€
2-VOUDIG • DOUBLE				
LM 40800	5420000066762	block	60	2,51
3-VOUDIG • TRIPLE				
LM 40803	5420000043954	1,5 m	40	7,39
4-VOUDIG • QUADRUPLE				
LM 40814	5420000043961	3 m	30	10,43
6-VOUDIG • SEXTUPLE				
LM 40826	5420000058903	5 m	20	15,28
3-VOUDIG + 2 USB-connecties • TRIPLE + 2 connections USB				
LM 40913	5420000064898	1,5 m	40	13,21

LM 40803

LM 40814

LM 40826

LM 40800



LM 40913

Stekker & stopcontact • Prise mâle et femelle



2P+A
2P+T
230V - 50 Hz

LM 48521

LM 48411

code		i		€
LM 48521	5420000046900	rubber / caoutchouc	30	4,14
LM 48411	5420000046917	rubber / caoutchouc	20	7,38
DUAL SYSTEM				
LM 48585	5420000046931	rubber / caoutchouc	20	5,64
LM 48455	5420000046924	rubber / caoutchouc	10	8,10

LM 48585

LM 48455

TOP SERIES!
2X SNELLER MONTEREN
FOIS PLUS VITE MONTÉ

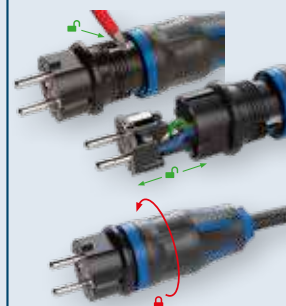

Contactblok met klapdeksel • Prise à clapets



2P+A
2P+T
230V - 50 Hz

LM 48200

LM 48300

code		i		€
LM 48200	5420000046979	dubbel / double	10	22,92
LM 48300	5420000046948	3-voudig / triple	5	36,50

zonder kabel / sans cable

CEE stekkers (M) - koppelstekkers (V) Fiches CEE male - femelle

EN 60309 CE



IP 44
2P+A
2P+T
250V - 16A

code	Barcode	Info	Quantity	Price
LM 44730	5420000043060	Man / Male	10	3,82
LM 44835	5420000043114	Vrouw / Femelle	10	5,00



IP 44
3P+N+A
3P+N+T
400V - 32A

code	Barcode	Info	Quantity	Price
LM 44753	5420000043084	Man / Male	10	7,02
LM 44863	5420000043138	Vrouw / Femelle	10	7,75



IP 44
3P+N+A
3P+N+T
400V - 16A

code	Barcode	Info	Quantity	Price
LM 44751	5420000043077	Man / Male	10	4,65
LM 44861	5420000043121	Vrouw / Femelle	10	5,68



IP 67
3P+N+A
3P+N+T
400V - 63A

code	Barcode	Info	Quantity	Price
LM 44755	5420000043091	Man / Male	5	33,40
LM 44865	5420000043145	Vrouw / Femelle	5	42,70

NEW



**MORE GRIP
MORE POWER**



IP 44/54
3P+N+A
3P+N+T
400V - 16A

code	Barcode	Info	Quantity	Price
LM 44646	5420000066700	Man / Male	10	9,35
LM 44662	5420000066717	Vrouw / Femelle	10	12,55

NEW



CLICK & LOCK

IP 44/54
3P+N+A
3P+N+T
400V - 16A

code	Barcode	Info	Quantity	Price
LM 44616	5420000066687	Man / Male	10	12,60
LM 44632	5420000066694	Vrouw / Femelle	10	14,82

CEE Compacte verdeelkasten Coffrets de distributions compactes CEE



LM 46105

LM 46101

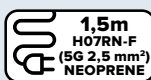

LM 46101 - LM 46105

Invoer / Entrée	1 x CEE 16A - 5P - 400V
Uitvoer / Sortie	1 x CEE 16A - 5P - 400V 2 x 16A - 250V
Stekkers / Prises	 F B

code				€
LM 46101	5420000049376	240 x 100 x 80 mm	2	42,90
LM 46105	5420000047099	240 x 100 x 80 mm	2	121,00

LM 46120 - LM 46122	
Invoer / Entrée	1 x CEE 16A - 5P - 400V
Uitvoer / Sortie	3 x CEE 16A - 5P - 400V
Stekkers / Prises	Universeel / Universel



LM 46120



LM 46122

code				€
LM 46120	5420000047105	200 x 170 x 80 mm	2	48,80
LM 46122	5420000047112	240 x 170 x 80 mm	2	100,00



LM 46138

LM 46134

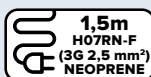

LM 46134 - LM 46138

Invoer / Entrée	1 x CEE 16A - 3P - 230V
Uitvoer / Sortie	3 x CEE 16A - 3P - 230V
Stekkers / Prises	Universeel / Universel

code				€
LM 46134	5420000047129	240 x 170 x 80 mm	2	44,30
LM 46138	5420000047136	240 x 170 x 80 mm	2	119,00

LM 46478		LM 46413
Invoer / Entrée	1 x CEE 16A - 5P - 400V	1 x CEE 32A - 5P - 400V
Uitvoer / Sortie	3 x 16A - 250V	3 x CEE 32A - 5P - 400V
Stekkers / Prises	 F B	Universeel / Universel

code				€
LM 46478	5420000047150	200 x 100 x 80 mm	5	37,10
LM 46413	5420000047143	295 x 190 x 100 mm	2	84,00



LM 46478

LM 46413

Verdeelkast - Elektrische werfkast Coffret de distribution électrique

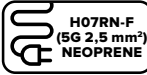

Max. 6400W



Franse stekker
Prise française



LM 47930

	LM 47930	LM 47923
Kabel type / Type de câble	H07RN-F / 5G 2,5 mm ²	H07RN-F / 5G 2,5 mm ²
Kabellengte / Longueur de câble	1,5 m	1,5 m
Max. Watt	6400W	6400W
Min. Watt	960W	960W
Invoer / Entrée	CEE 16A - 5P	CEE 16A - 5P
Uitvoer / Sortie	2 x 400V (16A) 4 x 230V (FR/BE)	2 x 400V (16A) 4 x 230V (SCHUKO)
IP-classificatie / Classification IP	IP44	IP44
Afmetingen / Dimensions	260 x 210 x 180 mm	255 x 250 x 180 mm
Stekkers / Prises	 F B	 D L

code		i	i		€
LM 47930	5420000067127	6400 W		1	116,00
LM 47923	5420000067110	6400 W		1	116,00

Verdeelkast - Elektrische werfkast met zekering Coffret de distribution électrique avec fusible



Max. 12800W



met zekering
avec fusible

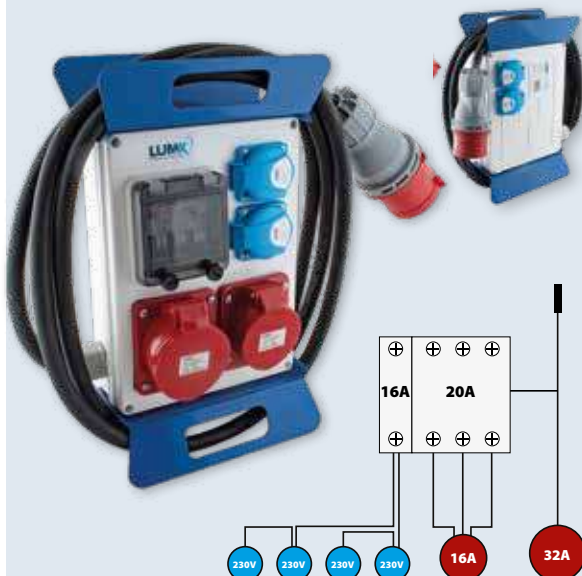

	LM 47954	LM 47986
Kabel type / Type de câble	H07RN-F / 5G 4 mm ²	H07RN-F / 5G 4 mm ²
Kabellengte / Longueur de câble	4 m	4 m
Max. Watt	12800W	12800W
Min. Watt	-	-
Invoer / Entrée	CEE 32A - 5P	CEE 32A - 5P
Uitvoer / Sortie	400V (1 x 32A - 1 x 16A) 4 x 230V (FR/BE)	400V (1 x 32A - 1 x 16A) 4 x 230V (SCHUKO)
IP-classificatie / Classification IP	IP44	IP44
Afmetingen / Dimensions	350 x 210 x 180 mm	350 x 250 x 180 mm
Stekkers / Prises	 F B	 D L

code		i	i		€
LM 47954	5420000067097	12800 W		1	197,00
LM 47986	5420000067103	12800 W		1	197,00

2023

Brutoprijzen excl. BTW en taksen geldig tot 31/12/2023 - Prix brut hors TVA et taxes valable jusqu'au 31/12/2023

Verdeelkast - Elektrische werfkast Coffret de distribution électrique



EN 61439



Max. 12800W

	LM 47110
Invoer / Entrée	1 x CEE 16A - 5P - 400V
Uitvoer / Sortie	2 x CEE 16A - 400V 4 x 16A - 250V
IP-classificatie / Classification IP	IP44
Afmetingen / Dimensions	200 x 197 x 197 mm
Stekkers / Prises	F B

code					€
LM 47110	5420000047167	12800 W	1		136,00

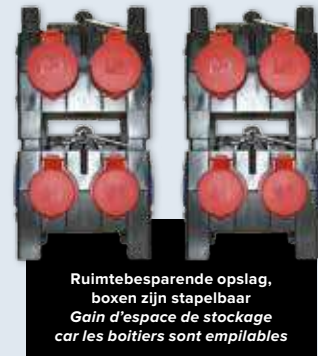

Ruimtebesparende opslag,
boxen zijn stapelbaar
Gain d'espace de stockage
car les boîtiers sont empilables

Verdeelkast - Elektrische werfkast met zekering Coffret de distribution électrique avec fusible



EN 61439



Max. 12800W

	LM 47117
Kabeltype / Type de câble	H07RN-F / 5G 4 mm ²
Kabellengte / Longueur de câble	2 m
Invoer / Entrée	1 x CEE 32A - 5P - 400V
Uitvoer / Sortie	1 x CEE 32A + 1 x 16A - 400V 3 x 16A - 250V
Zekering / Fusible	63A
IP-classificatie / Classification IP	IP44
Afmetingen / Dimensions	200 x 197 x 197 mm
Stekkers / Prises	F B

code					€
LM 47117	5420000047174	12800 W	1		371,00



met zekering
avec fusible



Ruimtebesparende opslag,
boxen zijn stapelbaar
Gain d'espace de stockage
car les boîtiers sont empilables

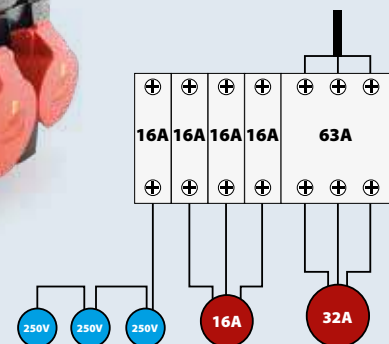

Standaard kabelhaspel BS HOME Enrouleur de câble standard BS HOME LM 80025 - LM 80050

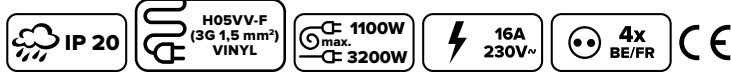

Thermische schakelaar
Disjoncteur thermique

Trommel kunststof
Tambour plastique

BS
HOME
VINYL



code	Barcode	Info	Icons	Rolls	Length	Price
LM 80025	5420000025004	25 m	BE, FR	4	80	58,10
LM 80050	5420000025011	50 m	BE, FR	2	48	99,50

Kabelhaspel PRO met driewegskoppelstekker Enrouleur de câble PRO avec fiche femelle triple LM 85728

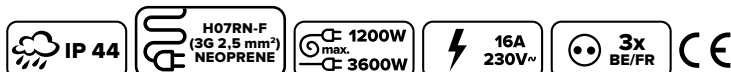

Thermische schakelaar
Disjoncteur thermique

Trommel kunststof
Tambour plastique

PRO
3 - WAY
NEOPRENE
HEAVY DUTY



code	Barcode	Info	Icons	Rolls	Length	Price
LM 85728	5420000043633	25 m	BE, FR	2	36	140,00

2023

Brutoprijzen excl. BTW en taksen geldig tot 31/12/2023 - Prix brut hors TVA et taxes valable jusqu'au 31/12/2023

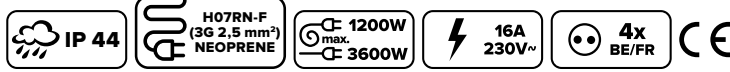
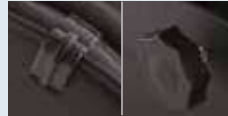
LUMX
POWER & LIGHTINGKabelhaspel PRO
Enrouleur de câble PRO LM 85025 - LM 85140Thermische schakelaar
Disjoncteur thermiqueTrommel kunststof
Tambour plastiquePRO
NEOPRENE
HEAVY DUTY

code	Barcode	Info	Outlets	Weight	Length	Price	ACTIE ACTION
LM 85025	5420000032255	25 m		2	36	112,00	106,00
LM 85140	5420000063662	40 m		2	36	159,00	149,00

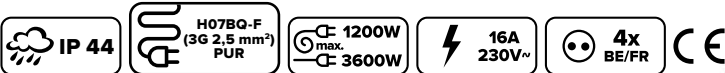
Kabelhaspel XT PREMIUM
Enrouleur de câble XT PREMIUM LM 88740Thermische schakelaar
Disjoncteur thermiqueTrommel aluminium
Tambour aluXT
PREMIUM
PUR
HEAVY DUTY

code	Barcode	Info	Outlets	Weight	Length	Price
LM 88740	5420000060630	40 m		2	24	225,00

Kabelhaspel XT PRO NO-TURN Enrouleur de câble XT PRO NO-TURN LM 87635

IP 44
 H07RN-F (3G 2,5 mm²) NEOPRENE
 1200W max. 3600W
 16A 230V~
 CE

TEMP RESISTANT -35°C / 70°C
 IMPACT RESISTANT 10N/mm

Thermische schakelaar
Disjoncteur thermique

Trommel kunststof
Tambour plastique

XT
PRO
NEOPRENE
HEAVY DUTY



NEW

35M

4x BE/FR

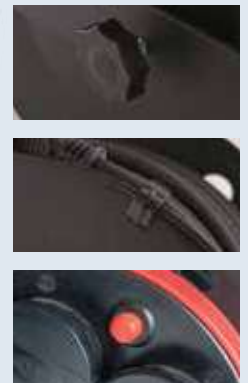

code	Barcode	Info	4x	BE/FR	2	36	€
LM 87635	5420000065291	35 m	4x	BE/FR	2	36	149,00

Kabelhaspel XT PRO Enrouleur de câble XT PRO LM 87240 - LM 87278

IP 44
 H07RN-F (3G 2,5 mm²) NEOPRENE
 1200W max. 3600W
 16A 230V~
 CE

TEMP RESISTANT -35°C / 70°C
 IMPACT RESISTANT 10N/mm

LM 87240

4x BE/FR

LM 87278

4x DE/NL

Thermische schakelaar
Disjoncteur thermique

Trommel kunststof
Tambour plastique

XT
PRO
NEOPRENE
HEAVY DUTY



code	Barcode	Info	4x	BE/FR	2	36	€	ACTIE ACTION
LM 87240	5420000060616	40 m	4x	BE/FR	2	36	179,00	159,00
LM 87278	5420000060623	40 m	4x	DE/NL	2	36	179,00	159,00

